

Modeling and Intelligent Control of Two-Tank Interacting Level Process

L.ThillaiRani, N.Deepa and S.Arulselvi

Abstract: The control of liquid level in tanks and flow between tanks is a basic problem in the process industries. In vital industries such as petro-chemical industries, paper industries, water treatment industries have the interacting tanks which the processes of chemical or mixing treatment takes place in the process tanks. Hence, the level of fluid in the tanks and interaction between tanks must be controlled. It is essential for control system engineers to understand how interacting tanks control system works and how the level control problem is solved. The problem of level control in interacting tank processes are system dynamics and interacting characteristics. In interacting process dynamics of tank1 affects the dynamics of tank2 and vice versa because flow rate depends on the difference between the liquid levels. In this work, a real-time two-tank interacting level process is taken-up for study. The mathematical model of a two-tank interacting process is derived. The hydraulic resistances (R_1 and R_2) are obtained using Experimental data. The servo and regulatory responses are obtained with PI controller. To improve the performance of the closed loop a Fuzzy Logic Controller (FLC) is designed and implemented for a two-tank interacting process. The servo and regulatory responses are obtained with FLC. The performances of Fuzzy Logic Controller are compared with PI controller in simulation. The performance measures are tabulated. It is observed from the results that the FLC out performs with no overshoot, faster settling time, better set-point tracking and thereby producing minimum integral square error(ISE).

Keywords: Two-tank interacting process, PI controller and FLC.

I. INTRODUCTION

The most widely used controllers in the industrial applications are the PI-type controller because of their simple structures and good performances. PI controllers are popular in industrial applications, as they are easy to install and reasonably robust. The controller is easily implemented, due to its simple configuration based on standard components. For highly nonlinear systems, the performance of PI controllers can deteriorate quite fast. It is necessary to

develop nonlinear PI controllers for controlling nonlinear processes. Fuzzy control has found promising applications

for a wide variety of industrial systems based on the universal approximation, many effective fuzzy control scheme have

been developed to incorporate with human experts knowledge and information in a systematic way, which can also guarantee various stability and performance criteria, not only for SISO nonlinear systems but also for MIMO nonlinear system [1]. The main advantages of these fuzzy-logic based control schemes lies in the fact that the developed controllers can deal with increasingly complex systems and to implement controllers without precise knowledge of the model structure of underlying dynamic systems. The conventional PI controller parameters are designed based on Ziegler-Nicholas method and its servo and regulatory responses are compared with Fuzzy logic controller based on mamdani model.

II. PROCESS DESCRIPTION

Fig.1 shows the photograph of the laboratory level process station. It consists of three pumps, two motorized control valves, six process tanks, two overhead tanks, two differential pressure transmitters, five level transmitters and rotameters. Instrumentation panel consists of two PID controllers, main power supply switch, pump switches, motorized control valve switches and auxiliary switches for individual components.

A. Working principles

Fluid level in the tank is measured by level transmitter (LT). Output of LT is given to the data acquisition setup. It consists of ADC and DAC. The differential pressure level transmitter (DPLT) measures the flow by sensing the difference in level between the tank. The DPLT then transmits a current signal(4-20mA) to the I/V converter. The output of the I/V converter is given to the interfacing hardware associated with the personal computer(PC). A control algorithms are implemented in Lab view software. It compares and takes corrective action on the motorized control valve. Based on the valve opening flow rate is manipulated. Rotameter can visualize the flow rate. The controller compares the controlled variable against set point and generates manipulated variable as current signal(4-20mA). Here the controlled variable is the level(h_2) and the manipulated variable is the flow rate(q_m). The Control valve gives restriction to the flow through the pipeline and hence the desired level is achieved.

Revised Manuscript Received on 30 March 2014.

* Correspondence Author

L. Thillai Rani*, Department of Electronics and Instrumentation Engineering, Annamalai University, Annamalai Nagar, Chidambaram (Tamil Nadu), India. E-mail: ltrani82@gmail.com

N.Deepa, Department of Electronics and Instrumentation Engineering, Annamalai University, Annamalai Nagar, Chidambaram (Tamil Nadu), Tamilnadu, India. E-mail: n.deepa2291@gamil.com

Dr. S.Arulselvi, Department of Electronics and Instrumentation Engineering, Annamalai University, Annamalai Nagar, Chidambaram (Tamil Nadu), India. E-mail: arulselvi_2k3@yahoo.co.in

© The Authors. Published by Blue Eyes Intelligence Engineering and Sciences Publication (BEIESP). This is an open access article under the CC-BY-NC-ND license <http://creativecommons.org/licenses/by-nc-nd/4.0/>.



Fig.1.Piping and Instrumentation diagram of two-tank interacting process.

TABLE I
SPECIFICATION OF TWO-TANK INTERACTING PROCESS

COMPONENTS	SPECIFICATIONS	
Motorised control valve	Flow rate Characteristics Valve action	- 500LPH - Equal% - Motorized control
Rotameter	Type Range Float material	- Variable area - (0-100)LPH (i.e 0-1666)cm ³ /min - SS 316
Pump	RPM Discharge Voltage	- 4500 - 1000(LPH) - 220/230 volts AC&DC
Process tank	Capacity Height Diameter	- 3 litres - 300 mm - 120 mm
Level transmitter	Input Height Type	- 24V DC - 0-400mm wc - RF Capacitance
Differential pressure transmitter	Input Supply Output	- 0-4000mm H ₂ O - 24V DC - 4-20mA at 24V DC

B. Mathematical modelling of a two-tank interacting level process

Consider the process consisting of two interacting liquid tanks in the Fig.2. The volumetric flow into tank1 is q_{in} (cm³/min), the volumetric flow rate from tank1 to tank2 is q_1 (cm³/min), and the volumetric flow rate from tank2 is q_o (cm³/min). The height of the liquid level is h_1 (cm) in tank1 and h_2 in tank2(cm). Both tanks have the same cross sectional area denotes the area of tank1 is A_1 (cm²) and area of tank2 is A_2 (cm²), q_{L1} is the inflow of tank1 as load disturbance(cm³/min) and q_{L2} is the inflow of tank2 as load disturbance(cm³/min) [2].

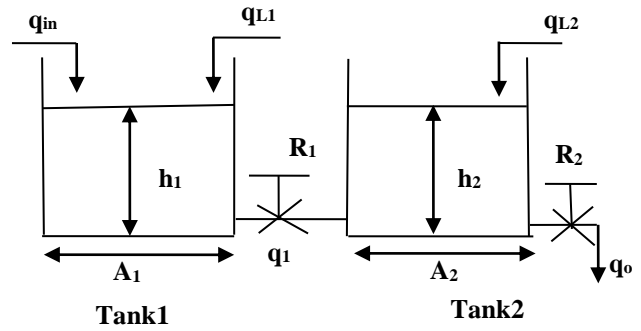

Fig.2.Two-tank interacting process.

For tank 1

$$A_1 \frac{dh_1}{dt} = q_{in} - q_1 \tag{1}$$

Assume linear resistance to flow

$$q_1 = \left(\frac{h_1 - h_2}{R_1} \right)$$

$$A_1 \frac{dh_1}{dt} = q_{in} - \left(\frac{h_1 - h_2}{R_1} \right) \tag{2}$$

$$A_1 R_1 \frac{dh_1}{dt} = R_1 q_{in} - h_1 + h_2 \tag{3}$$

Time constant of tank 1, $\tau_1 = A_1 R_1$

$$\tau_1 \frac{dh_1}{dt} + h_1 - h_2 = R_1 q_{in} \tag{4}$$

Taking laplace transform on both sides

$$\tau_1 s h_1(s) + h_1(s) - h_2(s) = R_1 q_{in}(s)$$

$$h_1(s)(\tau_1 s + 1) - h_2(s) = R_1 q_{in}(s) \tag{5}$$

For tank 2

$$A_2 \frac{dh_2}{dt} = q_1 - q_o \tag{6}$$

Assume linear resistance to flow

$$q_o = \left(\frac{h_2}{R_2} \right)$$

$$A_2 \frac{dh_2}{dt} = \left(\frac{h_1 - h_2}{R_1} \right) - \left(\frac{h_2}{R_2} \right) \tag{7}$$

$$A_2 R_2 \frac{dh_2}{dt} + h_2 + \frac{R_2}{R_1} h_2 = \frac{R_2}{R_1} h_1$$

Time constant of tank2 $\tau_2 = A_2 R_2$

$$\tau_2 \frac{dh_2}{dt} + h_2 + \frac{R_2}{R_1} h_2 = \frac{R_2}{R_1} h_1 \tag{8}$$

Taking laplace transform on both sides

$$\tag{9}$$

$$\tau_2 s h_2(s) + h_2(s) + \frac{R_2}{R_1} h_2(s) = \frac{R_2}{R_1} h_1(s)$$

$$h_2(s) \left(\tau_2 s + 1 + \frac{R_2}{R_1} \right) = \frac{R_2}{R_1} h_1(s) \quad (10)$$

To obtain $\frac{h_2(s)}{q_{in}(s)}$, cancel $h_1(s)$ in equations (5) & (10)

$$h_2(s) \left(\tau_2 s + 1 + \frac{R_2}{R_1} \right) (\tau_1 s + 1) - (\tau_1 s + 1) \frac{R_2}{R_1} h_1(s) = 0 \quad (11)$$

$$-h_2(s) \frac{R_2}{R_1} + h_1(s) (\tau_1 s + 1) \frac{R_2}{R_1} = q_{in}(s) R_2 \quad (12)$$

$$h_2(s) \left(\tau_1 \tau_2 s^2 + \tau_1 s + \frac{R_2}{R_1} \tau_1 s + \tau_2 s + 1 \right) = R_2 q_{in}(s) \quad (13)$$

where, Time constant of tank1, $\tau_1 = A_1 R_1$

$$h_2(s) (\tau_1 \tau_2 s^2 + \tau_1 s + \tau_2 s + A_1 R_2 s + 1) = R_2 q_{in}(s)$$

$$\frac{h_2(s)}{q_{in}(s)} = \frac{R_2}{\tau_1 \tau_2 s^2 + s(\tau_1 + A_1 R_2 + \tau_2) + 1} \quad (14)$$

Fig.3 shows the experimental open loop response for a step change of 30-40% in flow rate(q_{in}). The level of the tank2 is maintained around 6.8cm initially and raised and reached steady state at 8.5cm.

Fig.4 shows the experimental open loop response for a step change of 50-60% in flow rate(q_{in}). The level of the tank2 is maintained around 13.7cm initially and raised and reached steady state at 15.6cm.

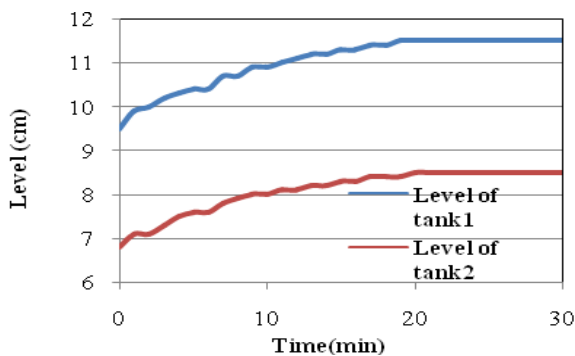

Fig.3.Experimental open loop response of interacting process for 30-40% in q_{in} .

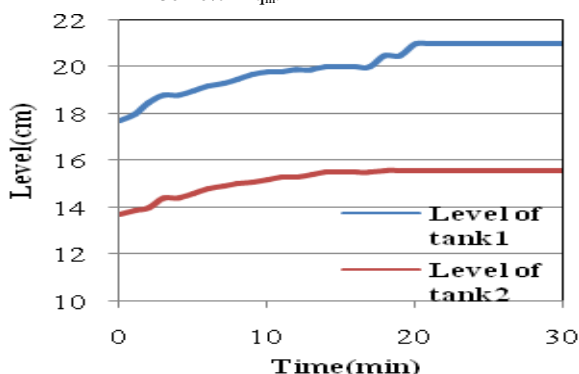

Fig.4.Experimental open loop response of interacting process for 50-60% in q_{in} .

From the open loop responses the hydraulic resistances R_1 and R_2 values are calculated [3]. The hydraulic resistances of tank1 and tank2 for various operating conditions are given in Table II.

TABLE II
 R_1 AND R_2 VALUES FOR DIFFERENT OPERATING CONDITIONS

C. Open loop responses for two-tank interacting process

Operating conditions	Area (cm ²)	Hydraulic resistance (R_1) min/cm ²	Hydraulic resistance (R_2) min/cm ²
30-40%	113.0973	0.004	0.01
50-60%	113.0973	0.004	0.01

Fig.5 shows the simulated open loop response of interacting process. The level (h_2) changes from 0 to 8.3cm, when applying a step input in q_{in} (50*16.66cm³/min) also the level (h_1) changes from 0 to 11.6cm due to interaction. The simulated process reaction curve(PRC) of h_2 for step change in q_{in} for ± 499.8 cm³/min is shown in Fig.6.

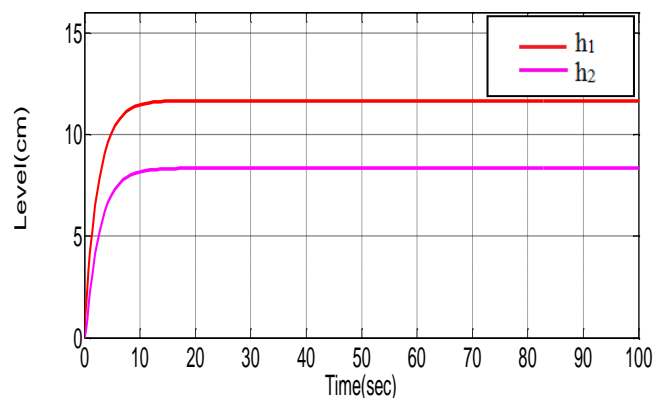

Fig.5. Simulated open loop response of h_1 and h_2 of interacting Process.

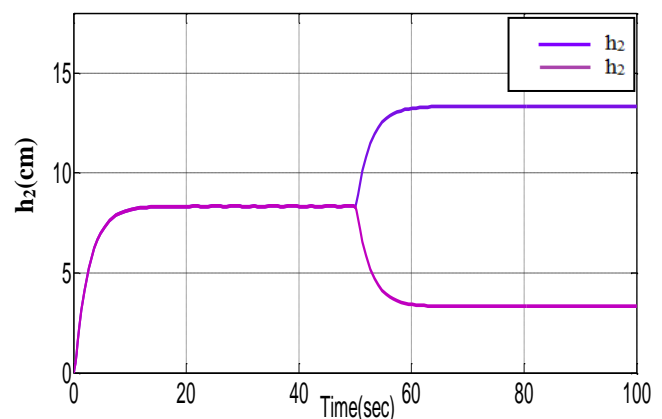

Fig.6.Simulated PRC of h_2 for step change in q_{in} for ± 499.8 cm³/min.

The transfer functions are obtained and tabulated in Table III. From the average transfer function, the controller parameters are obtained using Z-N tuning rule [4]&[5].

For two-tank interacting process the PI controller parameters are tabulated in Table IV.

TABLE III TRANSFER FUNCTION MODEL OF TWO-TANK INTERACTING PROCESS

Step Input(q_{in})	Transfer Function	Average Transfer Function
Positive Step Input(q_{in})	$\frac{5.1}{2.7s+1}e^{-0.1s}$	$\frac{5.1}{2.7s+1}e^{-0.1s}$
Negative Step Input(q_{in})	$\frac{5.1}{2.7s+1}e^{-0.1s}$	

TABLE IV. PI CONTROLLER SETTINGS FOR TWO-TANK INTERACTING PROCESS

Mode	K_c	$T_i(\text{sec})$
PI	4.7647	0.333

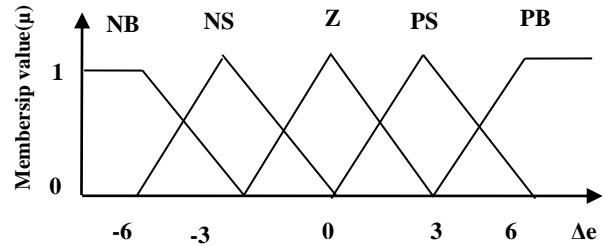

Fig.8(b). Membership diagram for change in error.

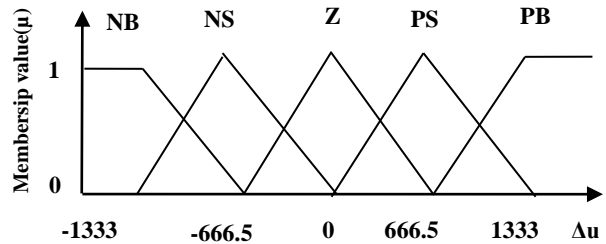

Fig.8(c). Membership diagram for change in controller output

III. F UZZY LOGIC CONTROLLER

The Fuzzy Logic Controller for a two-tank interacting process is shown in Fig.7.

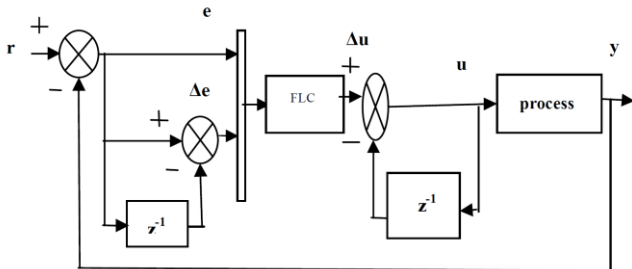

Fig.7.Fuzzy Logic controller to control the level of two-tank interacting process.

The fuzzy logic controller are designed with two input variables error and change in error, one output variable. The mamdani based fuzzy inference system uses linear membership function for both inputs and outputs [6]. Triangular membership functions are used for input and output variable [7]. The universe of discourse of error, change in error output are [-12 12]cm, [-6 6]cm and [-1333 1333]cm³/min. The membership function for error, change in error and change in controller output consist of negative big (NB), negative small (NS), zero (Z), positive small (PS) and positive big (PB). The membership diagram for error, change in error and change in controller output are shown in Fig.8(a), 8(b) and 8(c).

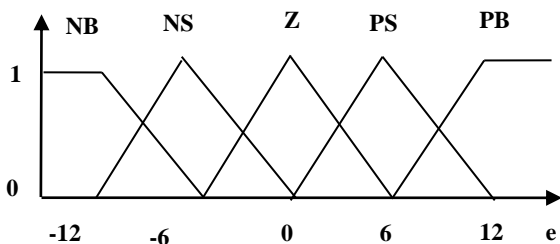

Fig.8(a). Membership diagram for error.

TABLE V FAM(CONTROL RULES)

(Δe) (e)	NB	NS	Z	PS	PB
NB	NB	NB	NS	NS	Z
NS	NB	NS	NS	Z	PS
Z	NS	NS	Z	PS	PS
PS	NS	Z	PS	PS	PB
PB	Z	PS	PS	PB	PB

IV. SIMULATION RESULTES

A. Servo responses of levels with PI and FLC

Fig.9 shows the set point tracking for level (h_2) with both PI and FLC from 8 to 12cm, 12 to 8cm, 8 to 4cm and 4 to 8cm. The level h_1 also increases from 10.4 to 16cm, 16 to 10.4cm, 10.4 to 4.8cm and 4.8 to 10.4cm due to interaction as shown in Fig.10. Also corresponding controller output q_{in} is shown in Fig.11. It is observed from figures that the PI controller takes more settling time for the level (h_2) and maximum integral square error.

The Fuzzy Logic Controller takes less settling time for the level (h_2), better set-point tracking, no overshoot and thereby producing minimum integral square error. The performance measures are tabulated in Table VI.

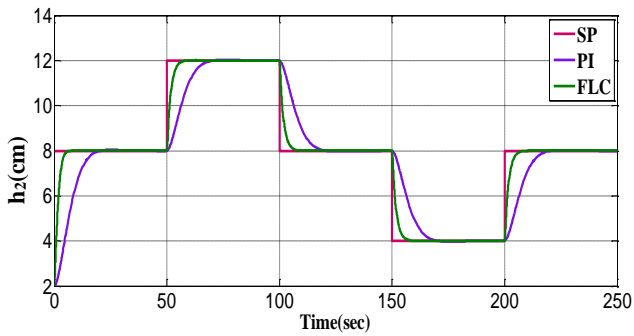

Fig.9. Servo response of h_2 with PI and Fuzzy Logic controller.

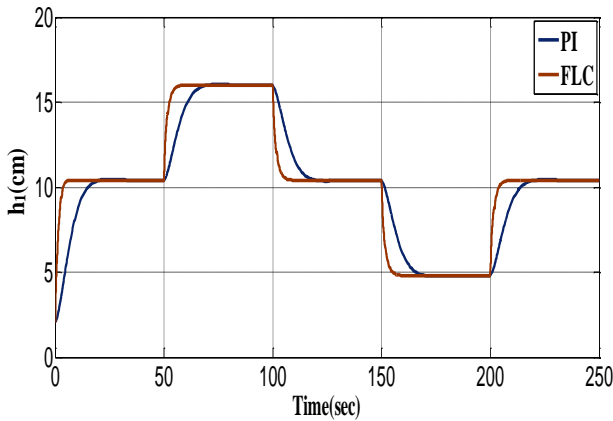

Fig.10. Servo response of h_1 with PI and FLC.

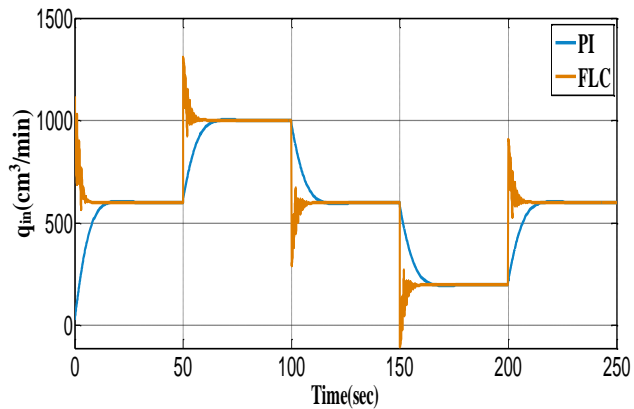

Fig.11. Response of PI and Fuzzy Logic Controller output (q_{in}) for servo response.

B. Regulatory responses of levels with PI and FLC (+6% load disturbance from q_{L2})

A sudden load disturbance of +6% is given in inlet flowrate of tank2 at 50th sample from q_{L2} as shown in Fig.2. Due to this level in h_2 increases from 8 to 9.5cm and controllers takes necessary action to reduce the flowrate, i.e from 600 to 450cm³/min(referring Fig.14) thereby decreasing h_1 from 10.4 to 8.3cm(referring Fig.13). The performance measures are tabulated in Table VII.

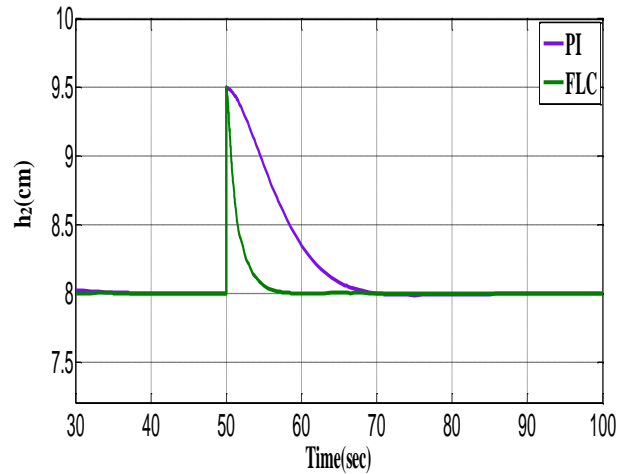

Fig.12. Regulatory response of h_2 with PI and FLC due to load variation in +6% from q_{L2} .

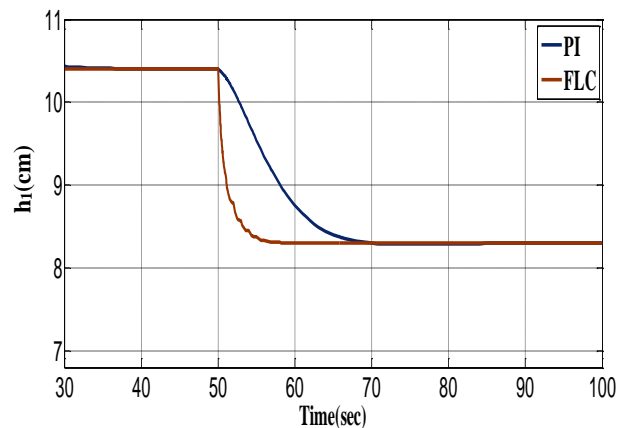

Fig.13. Regulatory response of h_1 with PI and FLC due to load variation in +6% from q_{L2} .

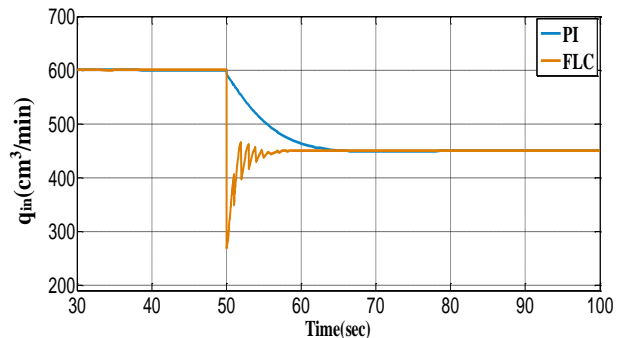

Fig.14. Response of PI and FLC output (q_{in}) for load variation in +6% from q_{L2} .

C. Regulatory responses of levels with PI and FLC (-6% load disturbance from q_{L2})

A sudden load disturbance of -6% is given in inlet flowrate of tank2 at 50th sample from q_{L2} as shown in Fig.2. Due to this level in h_2 decreases from 8 to 6.5cm and controller takes necessary action to increase the flowrate, i.e from 600 to 750cm³/min(referring Fig.17) thereby increasing h_1 from 10.4 to 12.5cm(referring Fig.16). The performance measures are tabulated in Table VII.

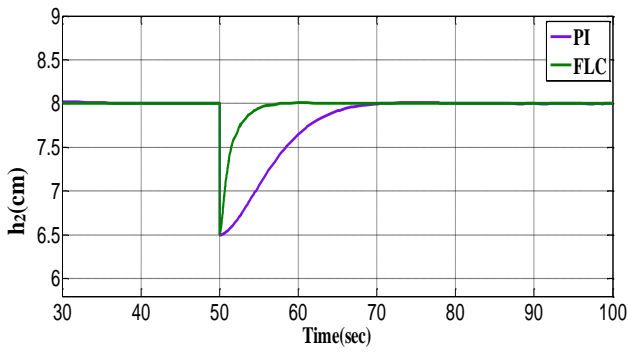

Fig.15. Regulatory response of h_2 with PI and FLC due to load variation in -6% from q_{L2} .

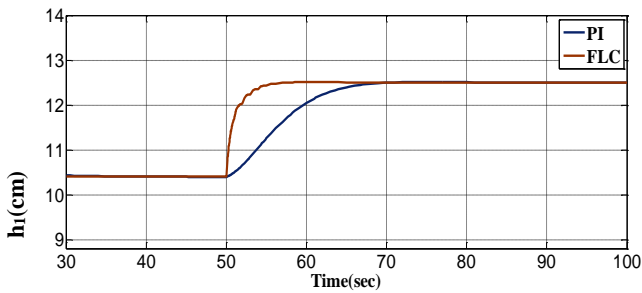

Fig.16. Regulatory response of h_1 with PI and FLC due to load variation in -6% from q_{L2} .

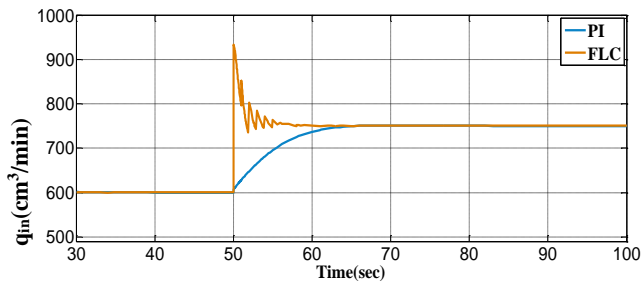

Fig.17. Response of PI and FLC output (q_{in}) for load variation in -6% from q_{L2} .

D. Regulatory responses of levels with PI and FLC (+6% load disturbance from q_{L1})

A sudden load disturbance of +6% is given in inlet flowrate of tank1 at 50th sample from q_{L1} as shown in Fig.2. Due to this level in h_1 increases from 10.4 to 12cm as shown in Fig.19. The level h_2 also increases from 8 to 9.1cm due to interaction and Controller takes necessary action to reduce the flowrate, i.e from 600 to 434 cm^3/min . The performance measures are tabulated in Table VII. The responses of h_2 , h_1 and q_{in} are shown in Fig.18, 19 and 20, respectively.

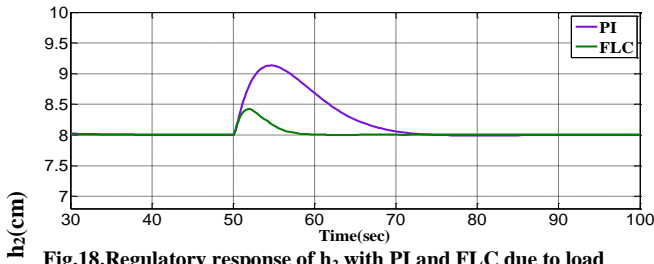

Fig.18. Regulatory response of h_2 with PI and FLC due to load variation in +6% from q_{L1} .

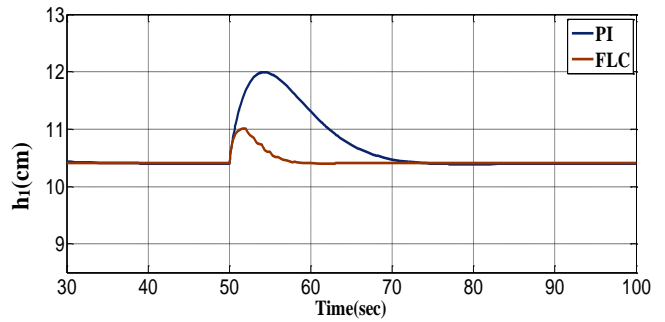

Fig.19. Regulatory response of h_1 with PI and FLC due to load variation in +6% from q_{L1} .

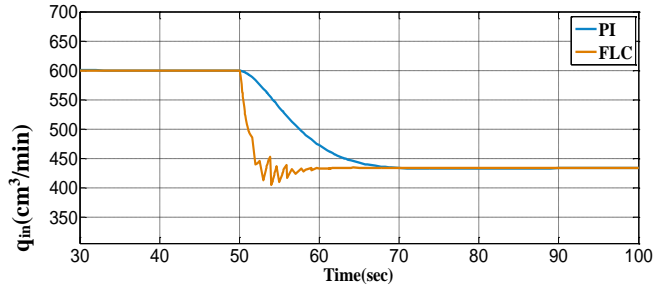

Fig.20. Response of PI and FLC output (q_{in}) for load variation in +6% from q_{L1} .

E. Regulatory responses of levels with PI and FLC (-6% load disturbance from q_{L1})

A sudden load disturbance of -6% is given in inlet flowrate of tank1 at 50th sample from q_{L1} as shown in Fig.2. Due to this level in h_1 decreases from 10.4 to 8.8cm as shown in Fig.22. The level h_2 also decreases from 8 to 6.9cm due to interaction and Controller takes necessary action to increase the flowrate, i.e from 600 to 766 cm^3/min . The performance measures are tabulated in Table VII. The responses of h_2 , h_1 and $q_{in}(u)$ are shown in Fig.21, 22 and 23 respectively.

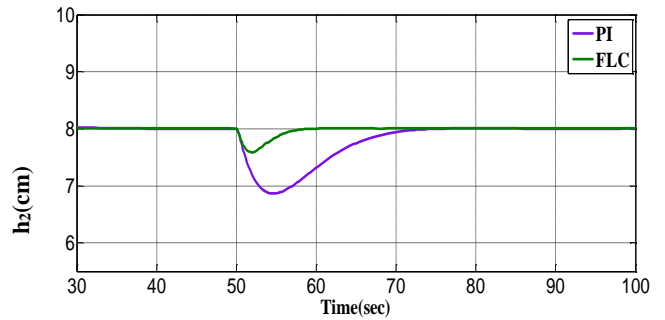

Fig.21. Regulatory response of h_2 with PI and FLC due to load variation in -6% from q_{L1} .

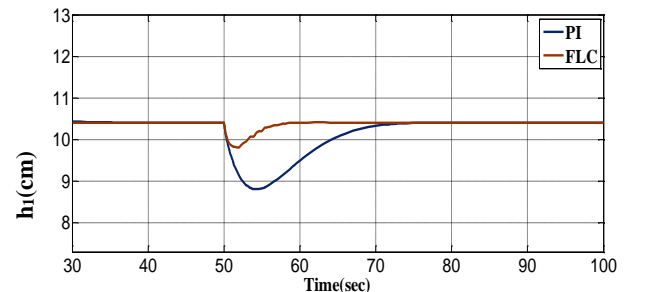

Fig.22. Regulatory response of h_1 with PI and FLC due to load variation in -6% from q_{L1} .

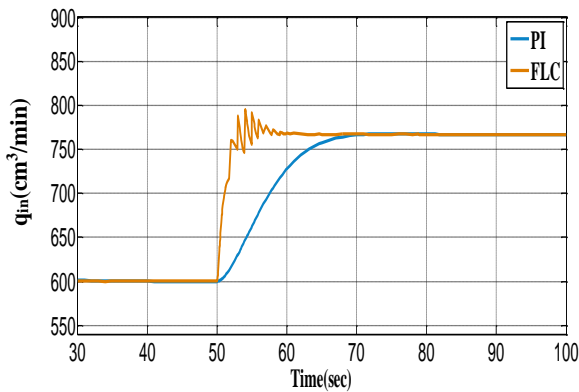

Fig.23. Response of PI and FLC output(q_{in}) for load variation in -6% from q_{L1} .

TABLE VI. COMPARISON OF PERFORMANCE MEASURES OF LEVELS WITH PI AND FLC FOR SERVO RESPONSE

Controller	Servo Response $h_2(2-8)cm$	
	t_s (sec)	ISE
PI	35	168
FLC	10	33.64

TABLE VII
COMPARISON OF PERFORMANCE MEASURES OF LEVELS WITH PI AND FLC FOR REGULATORY RESPONSE

	Regulatory Response $h_2(2-8)cm$							
	+6% from q_{L2}		-6% from q_{L2}		+6% from q_{L1}		-6% from q_{L1}	
	t_s	ISE	t_s	ISE	t_s	ISE	t_s	ISE
	(sec)		(sec)		(sec)		(sec)	
PI	20	10.4	20	10.5	25	9.5	25	9.5
FLC	8	1.7	8	1.7	9	0.4	9	0.4

V. CONCLUSION

The mathematical model of a two-tank interacting process was derived. The hydraulic resistances (R_1 and R_2) were obtained using experimental data. The servo and regulatory responses were obtained with PI controller. To improve the performance of closed loop, a Fuzzy Logic Controller was designed and implemented for a two-tank interacting process. The servo and regulatory responses were obtained with Fuzzy Logic Controller. The performances of Fuzzy Logic Controller were compared with PI controller in simulation. The performance measures were tabulated. The servo and regulatory responses of two-tank interacting process shows that the FLC performance is better in terms of less integral square error, faster settling time and better set-point tracking when compared with PI controller.

REFERENCES

1. E.P.Gatzke,E.S.Meadows,C.Wang,and F.J.Doyle, "Model Based Control of A Four-Tank System", *Computer and Chemical Engineering*, Vol.24, pp 1503-1509, 2000.

2. George Stephanopoulos, "Chemical Process Control-An Introduction to Theory and Practice", PHI Learning Private Limited New Delhi, 2009.
3. Bhuvaneswari N S, Praveena R, Divya R, "System Identification and Modeling for Interacting and Non-Interacting Tank System Using Intelligent Techniques", *ARSV:1208.1103V*, August 2012.
4. Donald R.Coughnour, "Process Systems Analysis and Control", McGraw Hill International Editions, Second Edition, 1991.
5. Ziegler.G and Nichols.N.B "Optimum Setting for Automatic Controllers", *Trans ASME* .64, pp 759-768, 1942.
6. Chao.C.T and C.C.Teng, "A PD Like Self Tuning Fuzzy Controller Without Steady State error", *Fuzzy set syst.*, 87(2), pp:141-15, 2000.
7. S.J.Qin and G.Borders, " A Multiregion Fuzzy Logic Controller for Non Linear Process Controller", *IEE Trans on Fuzzy Systems* PP 74-81,1994.
8. B.WayneBequette,"Process Control-Modeling,Design and Simulation", Prentice-Hall of India Private Limited, New Delhi, 2004.
9. M.Chidambaram, "Computer Control of Process", Narosa Publishing House, New Delhi, 2002.
10. Tri Chandra S.Wibowo, Nordin saad,and Mohd Noh Karsiti, "System Identification of an Interacting Series Process for Real-Time Model Predictive Control", *American Control Conference*, pp.4384-4389, June 2009.
11. Curtis D.Johnson, "Process Control Instrumentation Technology", Prentice Hall of India, Seventh Edition, 2004. .

AUTHOR PROFILE



L.ThillaiRani received her B.E., Electronics and Instrumentation from Annamalai University in 2004, M.E Process Control and Instrumentation from Annamalai University in 2006. Currently working as a Assistant Professor in the Deptt.of Instrumentation Engg., Annamalai University. Her area of interests includes Process control and Industrial Instrumentation.



N.Deepa received her B.E., Electronics and Instrumentation, from Annamalai University in 2012 and M.E., Process control and Instrumentation from Annamalai University in 2014. Her area of interests includes process control and industrial instrumentation.



Dr. S. Arulselvi received her B.E., Instrumentation and Control from Govt. College of Technology, Coimbatore in 1988, M.E., Control and Instrumentation from Anna University in 1998 and Ph.D. in Power Electronics from Anna University in 2007. Currently working as a Professor in the Dept.of Instrumentation Engg., Annamalai University. Her area of interests includes Digital watermarking, process control, Image processing, Power Electronics etc.